

1. A view of the camera's I/O interface

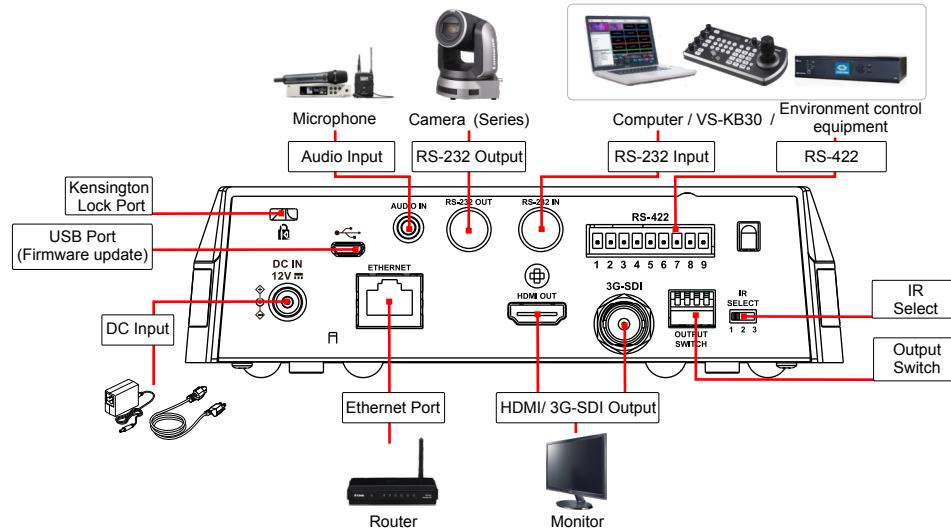

2. Instruction on DIP SWITCH setting

2.1 OUTPUT SWITCH



Output Mode	Setting
1920x1080/60p	
1920x1080/50p	
1920x1080/30p	
1920x1080/25p	
1920x1080/60i	
1920x1080/50i	
1280x720/60p	
1280x720/50p	
1080/59.94p	
1080/59.94i	
1080/29.97p	
720/59.94p	

2.2 IR SELECT

After the IR SELECT is configured, it can be switched from the Camera Select on the remote control

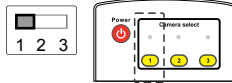

ID	Setting
1	
2	
3	

2.3 Camera Address Selector



Setting	Function Descriptions
0~7	ID 0~7
8~9	Reserved

2.4 System Switch



Setting	Function Descriptions
DIP 1	RS-232C/RS-422 selector OFF: RS-232C / ON : RS-422
DIP 2	Infrared signal output switch OFF: Off / ON : On
DIP 3	Communication baud rate selector OFF: 9600 / ON : 38400
DIP 4	Reserved

3. Install the camera on the ceiling

1. Please adjust the resolution on **DIP SWITCH** prior to installation.
(Please refer to [2. Instruction on DIP SWITCH setting](#))
2. Fix the metal plate **A** on the machine base with **4 M3** silver screws.

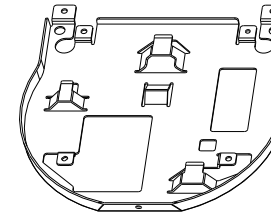

metal plate A

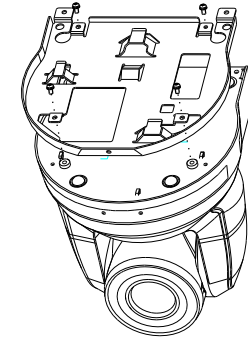

3. Lock the metal plate **B** on ceiling mounted hanger

***Caution:**

- (1) Please use the hanger that has obtained UL security approval.
- (2) Please reserve the hole for the connecting wires of the camera.

4. Combine the metal plate **A** and the metal plate **B**

- ▼ Push the metal plate **A** up to the ceiling and then to the right to latch the metal plate **B**.
- ▼ And then secure with **2 M3** silver screws and **1 M3** black screw.

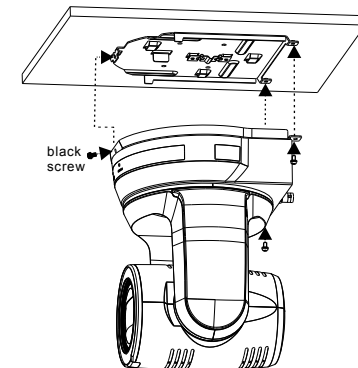

4. About the power supply

- Connect the DC12V power adapter for power supply
 - Access power by using a router that supports PoE or connecting to a hub with a network cable
- ※ VC-A51P/VC-A51PN supports PoE+(IEEE802.3at)

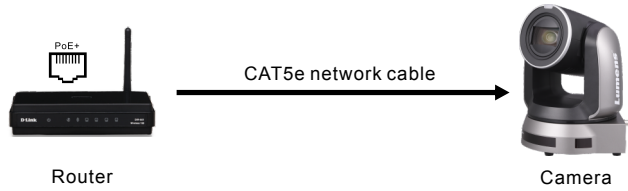

5. Camera connection description

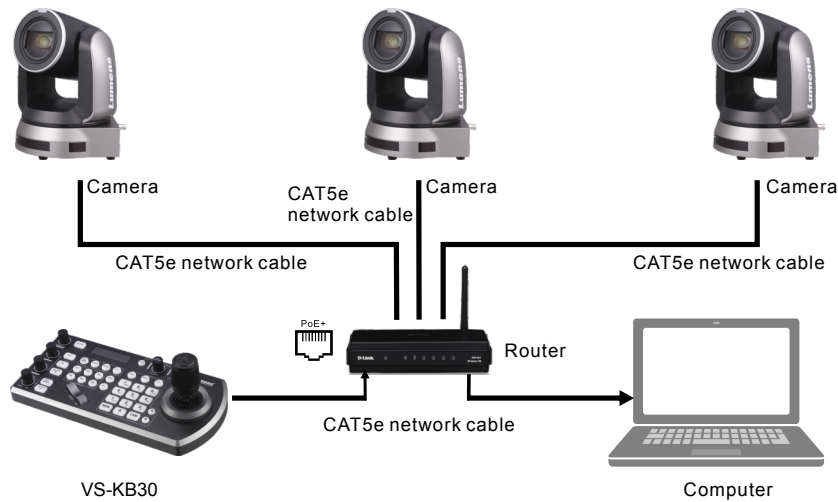

6. Web page setting

Open the browser, enter the camera IP address, enter the account and password, you can enter the web page to set and control the camera.

Address

- *The IP address can be verified by clicking [MENU] => [Ethernet] => [IP Address] on the remote control
- *If it is not connected to a DHCP router, the default IP address is 192.168.100.100

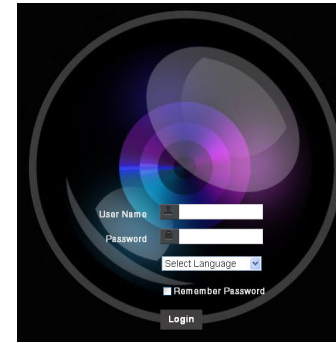

Account: admin
Password: 9999

*For the NDI|HX operation of VC-A51PN, please download the latest NDI software from the NewTek website.